



Triaxial Contact Series

Sabritec's concentric twinax/triax contacts provide flexibility in the design of high speed data systems. The contacts, including the unique sizes 10 and 12, have the same outline dimensions as traditional coax and power contacts and fit various insert arrangements for d-sub, circular, and rack and panel connectors. The triaxial cable type connectors and contacts are designed for low-loss concentric 50, 75 and 95 ohm cable types.

An innovative design of triax/twinax contacts opens a whole new world of design options. These small, rugged contacts fit standard connector contact cavities for MIL-DTL-38999, MIL-DTL-83527, ARINC, and d-sub connector types.

Sabritec also manufactures a complete line of stand-alone triax connectors including the ultraminiature NDL connector series as well as other specific application configurations.

FEATURES

- Fits standard MIL-DTL-38999 size 8, 10 & 12 contact cavities, MIL-DTL-83527 size 8, d-sub size 8, and ARINC size 1, 5, 8, 9 & 12 standard rack & panel connector cavities.
- Designed for MIL-C-17/176 Data Bus networks and high speed Ethernet and Fibre Channel system
- Suitable for high speed video applications, 50, 75 & 95 ohm impedances
- Upgrade coax harnesses to triax capability
- Small size for high density packaging
- Includes high speed Fibre Channel hot-link product line series

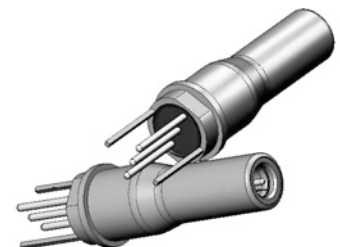



Concentric Twinax/Triax Contacts

Contact Specifications

INTERFACE DIMENSIONS

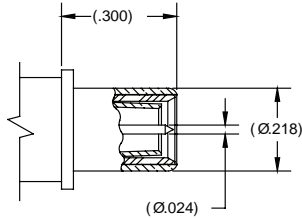
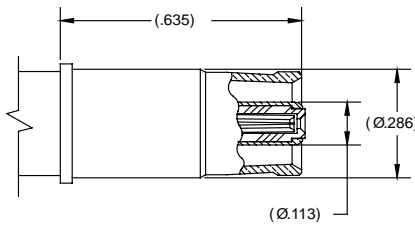

SIZE 8, MIL-C-39029/90 & /91

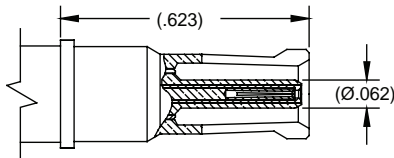
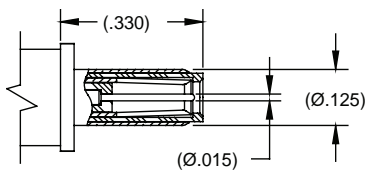

SIZE 10, MIL-DTL-38999

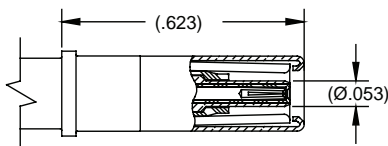
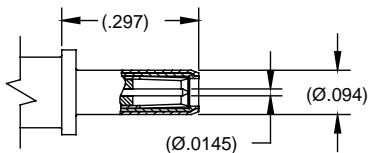

SIZE 12, MIL-DTL-38999

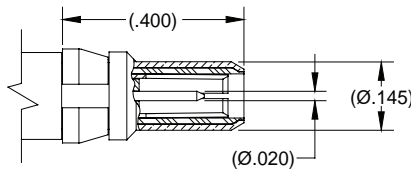

SIZE 8, MIL-PRF-24308

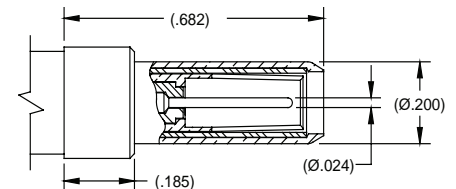

SIZE 9, MIL-C-81659 (ARINC 404)

Mechanical & Environmental Specifications	
Temperature Rating	-65°C to + 165°C
Corrosion	MIL-STD-202 Method 101, Test Condition B
Shock	MIL-STD-202 Method 213, Test Condition B
Vibration	MIL-STD-202 Method 204, Test Condition B
Thermal Shock	MIL-STD-202 Method 107, Test Condition B
Durability	1000 Mate/Unmate cycles min.
Electrical Specifications	
Dielectric Withstanding Voltage	Center contact to intermediate contact: 1000 Vrms min. Size 12: 500 Vrms min. Intermediate contact to outer contact: 400 Vrms min. Size 12: 200 Vrms min
Insulation Resistance	5000 Mega-Ohms min. @ 200 VDC
Contact Current Rating	3.0 Amps D.C. max.: Size 12: 1.5 Amps D.C. max.
Voltage Rating	500 Vrms @ sea level: Size 12: 200 Vrms @ sea level
Material & Finishes	
Shell & Center/Intermediate Contacts	Brass per ASTM-B16, Alloy UNS C36000 or BeCu per ASTM-B196, Alloy UNS C17200, C17300 or Leaded Nickel Copper, Alloy UNS C19500, C19600 Gold plate per MIL-DTL-45204, Type II, Class 1
Insulators	PTFE per ASTM-D 1710 or equivalent
Hood	305 CRES per ASTM-A240, passivated per ASTM-A967

All specifications subject to change without notice.



Concentric Twinax/Triax Contacts

MIL-DTL-38999 Pin Contacts

Size 8 MIL-C-39029/90 Twinax/Triax Pin Contact

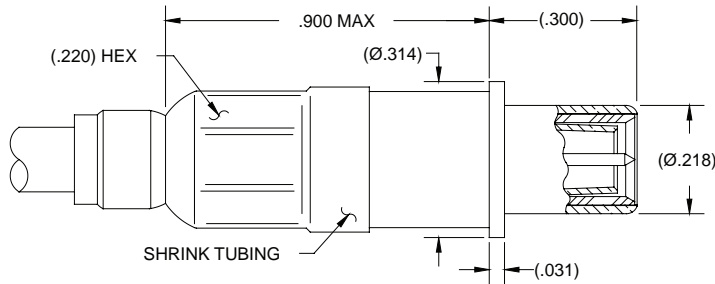

Part Number	Cable Type	Cable
019612-2001	Flexible Twinax	M17/176-00002
019612-2002	Flexible Twinax	540-1086-000
019612-2003	Flexible Triax	RG-403
019612-2004	Flexible Triax	540-1050-000
019612-2031	Flexible Triax	540-1081-000

Size 10 MIL-DTL-38999 Twinax/Triax Pin Contact

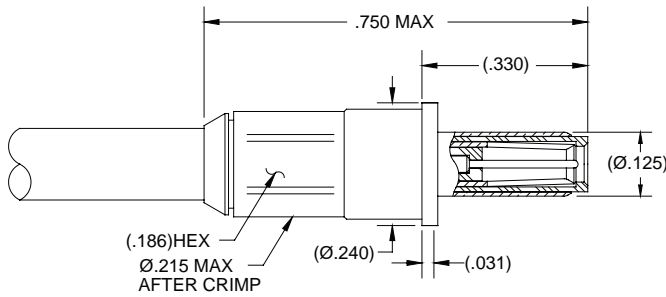

Part Number	Cable Type	Cable
018812-2001	Flexible Twinax	M17/176-00002
018812-2002	Flexible Twinax	540-1086-000
018812-2003	Flexible Triax	RG-403
018812-2004	Flexible Triax	540-1050-000
018812-2031	Flexible Triax	540-1081-000

Size 12 MIL-DTL-38999 Twinax/Triax Pin Contact

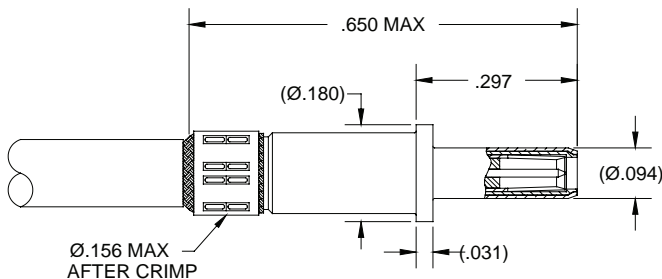

Part Number	Cable Type	Cable
018612-2001	Flexible Twinax	M17/176-00002
018612-2002	Flexible Twinax	540-1086-000
018612-2003	Flexible Triax	RG-403
018612-2004	Flexible Triax	540-1050-000
018612-2041	Flexible Triax	540-1081-000



Concentric Twinax/Triax Contacts

MIL-DTL-38999 Socket Contacts

Size 8 MIL-C-39029/91 Twinax/Triax Socket Contact

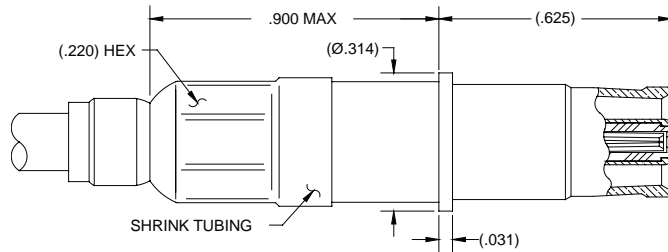

Part Number	Cable Type	Cable
019512-2001	Flexible Twinax	M17/176-00002
019512-2002	Flexible Twinax	540-1086-000
019512-2003	Flexible Triax	RG-403
019512-2004	Flexible Triax	540-1050-000
019512-2031	Flexible Triax	540-1081-000

Size 10 MIL-DTL-38999 Twinax/Triax Socket Contact

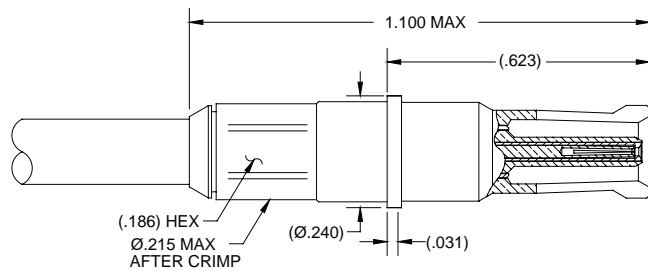

Part Number	Cable Type	Cable
018912-2001	Flexible Twinax	M17/176-00002
018912-2002	Flexible Twinax	540-1086-000
018912-2003	Flexible Triax	RG-403
018912-2004	Flexible Triax	540-1050-000
018912-2031	Flexible Triax	540-1081-000

Size 12 MIL-DTL-38999 Twinax/Triax Socket Contact

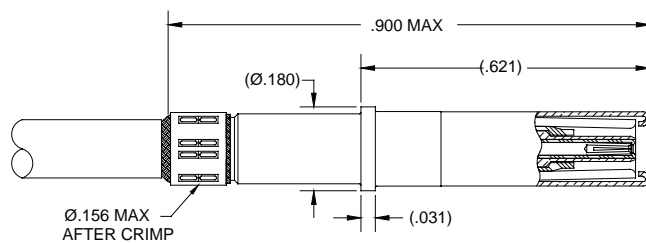

Part Number	Cable Type	Cable
018712-2001	Flexible Twinax	M17/176-00002
018712-2002	Flexible Twinax	540-1086-000
018712-2003	Flexible Triax	RG-403
018712-2004	Flexible Triax	540-1050-000
018712-2041	Flexible Triax	540-1081-000

Concentric Twinax/Triax Contacts

MIL-DTL-38999/MIL-PRF-24308 Twinax/Triax Pin Contacts

Size 8 MIL-C-39029/90 Twinax/Triax Right Angle Pin Contact

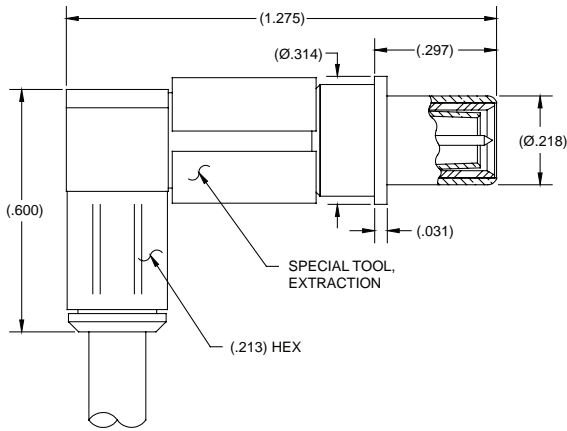

Part Number	Cable Type	Cable
019612-1010	Flexible Twinax	M17/176-00002
019612-1011	Flexible Twinax	540-1086-000
019612-1012	Flexible Triax	RG-403
019612-1013	Flexible Triax	540-1050-000
019612-1016	Flexible Triax	540-1081-000

Size 8 MIL-PRF-24308 Twinax/Triax Pin Contact

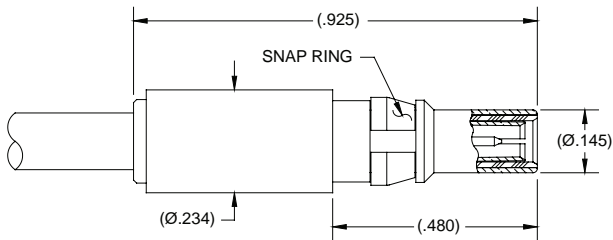

Part Number	Cable Type	Cable
019812-2001	Flexible Twinax	M17/176-00002
019812-2002	Flexible Twinax	540-1086-000
019812-2003	Flexible Triax	RG-403
019812-2004	Flexible Triax	540-1050-000
019812-2031	Flexible Triax	540-1081-000

Size 8 MIL-PRF-24308 Twinax/Triax Right Angle Pin Contact

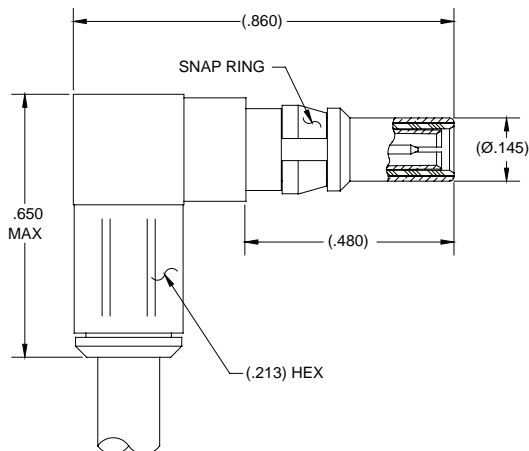

Part Number	Cable Type	Cable
019812-1010	Flexible Twinax	M17/176-00002
019812-1011	Flexible Twinax	540-1086-000
019812-1012	Flexible Triax	RG-403
019812-1013	Flexible Triax	540-1050-000
019812-1016	Flexible Triax	540-1081-000



Concentric Twinax/Triax Contacts

MIL-DTL-38999/MIL-PRF-24308 Twinax/Triax Socket Contacts

Size 8 MIL-C-39029/91 Twinax/Triax Right Angle Socket Contact

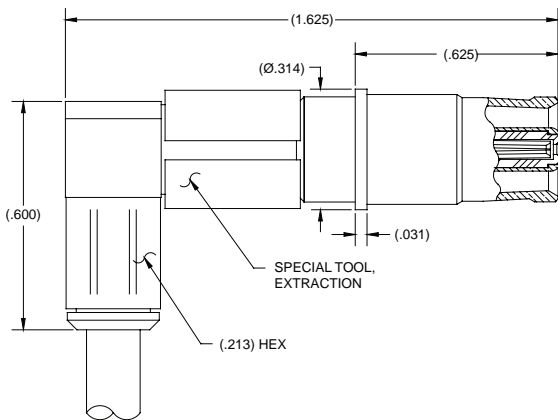

Part Number	Cable Type	Cable
019512-1010	Flexible Twinax	M17/176-00002
019512-1011	Flexible Twinax	540-1086-000
019512-1012	Flexible Triax	RG-403
019512-1013	Flexible Triax	540-1050-000
019512-1016	Flexible Triax	540-1081-000

Size 8 MIL-PRF-24308 Twinax/Triax Socket Contact

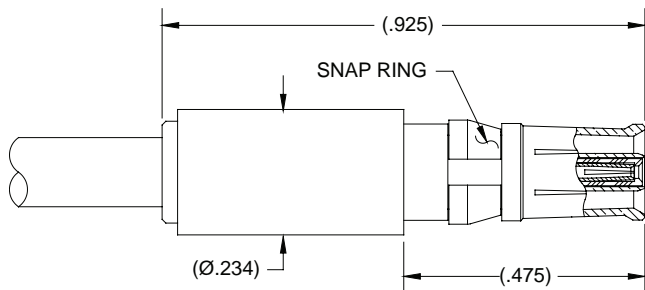

Part Number	Cable Type	Cable
019712-2001	Flexible Twinax	M17/176-00002
019712-2002	Flexible Twinax	540-1086-000
019712-2003	Flexible Triax	RG-403
019712-2004	Flexible Triax	540-1050-000
019712-2031	Flexible Triax	540-1081-000

Size 8 MIL-PRF-24308 Twinax/Triax Right Angle Socket Contact

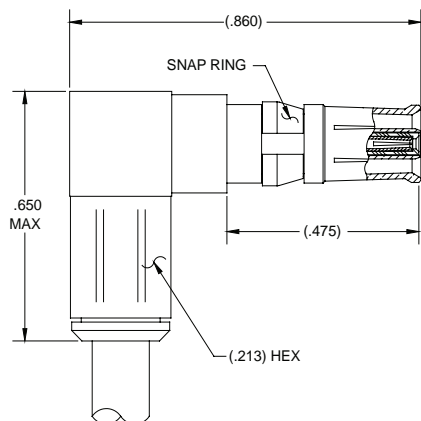

Part Number	Cable Type	Cable
019712-1010	Flexible Twinax	M17/176-00002
019712-1011	Flexible Twinax	540-1086-000
019712-1012	Flexible Triax	RG-403
019712-1013	Flexible Triax	540-1050-000
019712-1016	Flexible Triax	540-1081-000

Size 1 ARINC 600 Twinax/Triax Pin Contact

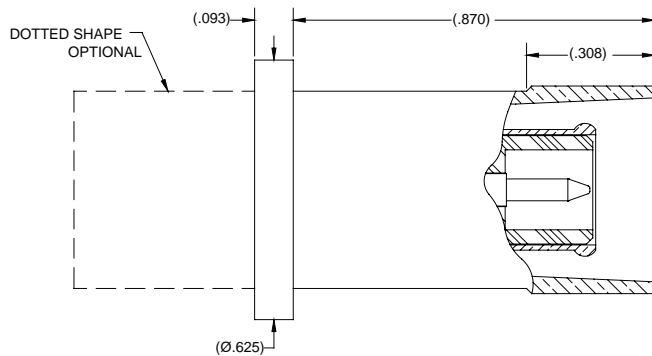

Part Number	Cable Type	Cable
018012-2110	Flexible Twinax	M17/176-00002
018012-2111	Flexible Twinax	540-1086-000
018012-2112	Flexible Triax	RG-403
018012-2113	Flexible Triax	540-1050-000
018012-2114	Flexible Triax	540-1081-000

Size 5 ARINC 600 Twinax/Triax Pin Contact

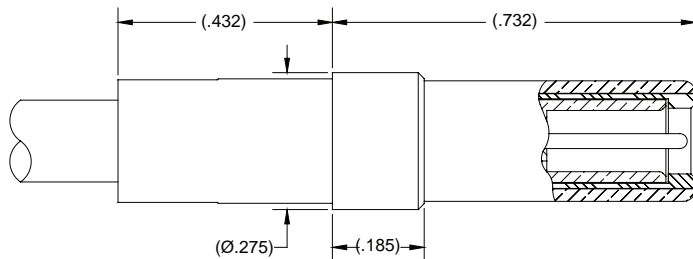

Part Number	Cable Type	Cable
019412-2110	Flexible Twinax	M17/176-00002
019412-2111	Flexible Twinax	540-1086-000
019412-2112	Flexible Triax	RG-403
019412-2113	Flexible Triax	540-1050-000
019412-2116	Flexible Triax	540-1081-000

Size 12 ARINC 600 Twinax/Triax Pin Contact

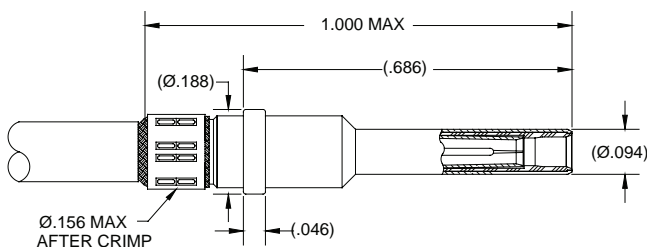

Part Number	Cable Type	Cable
018612-2110	Flexible Twinax	M17/176-00002
018612-2111	Flexible Twinax	540-1086-000
018612-2112	Flexible Triax	RG-403
018612-2113	Flexible Triax	540-1050-000
018612-2116	Flexible Triax	540-1081-000



Concentric Twinax/Triax Contacts

ARINC 600 Socket Contacts

Size 1 ARINC 600 Twinax/Triax Socket Contact

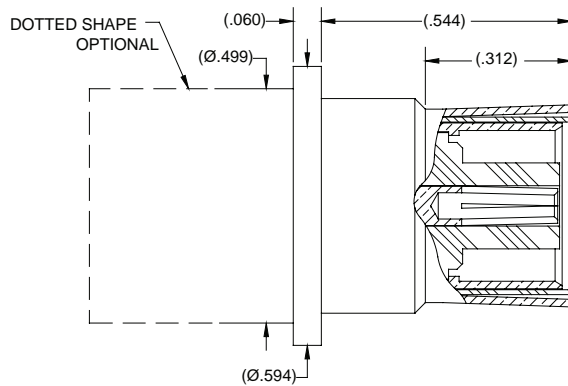

Part Number	Cable Type	Cable
018112-2110	Flexible Twinax	M17/176-00002
018112-2111	Flexible Twinax	540-1086-000
018112-2112	Flexible Triax	RG-403
018112-2113	Flexible Triax	540-1050-000
018112-2114	Flexible Triax	540-1081-000

Size 5 ARINC 600 Twinax/Triax Socket Contact

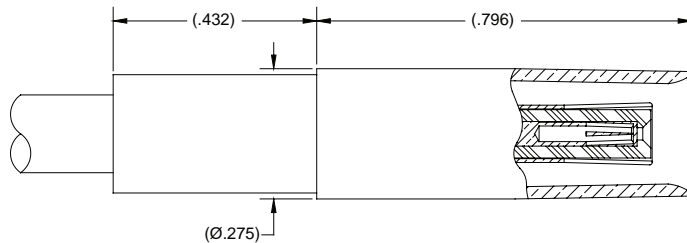

Part Number	Cable Type	Cable
019312-2110	Flexible Twinax	M17/176-00002
019312-2111	Flexible Twinax	540-1086-000
019312-2112	Flexible Triax	RG-403
019312-2113	Flexible Triax	540-1050-000
019312-2116	Flexible Triax	540-1081-000

Size 12 ARINC 600 Twinax/Triax Socket Contact

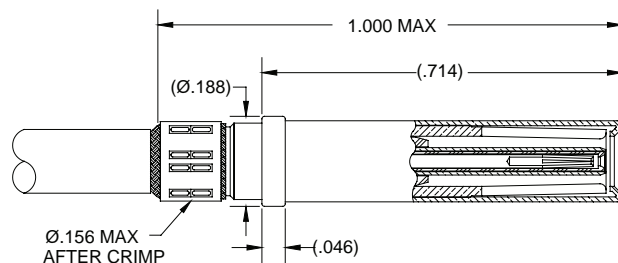

Part Number	Cable Type	Cable
018712-2110	Flexible Twinax	M17/176-00002
018712-2111	Flexible Twinax	540-1086-000
018712-2112	Flexible Triax	RG-403
018712-2113	Flexible Triax	540-1050-000
018712-2116	Flexible Triax	540-1081-000



Concentric Twinax/Triax Contacts

MIL-DTL-83527/ARINC 404 Contacts

Size 8 MIL-DTL-83527 Twinax/Triax Socket Contact

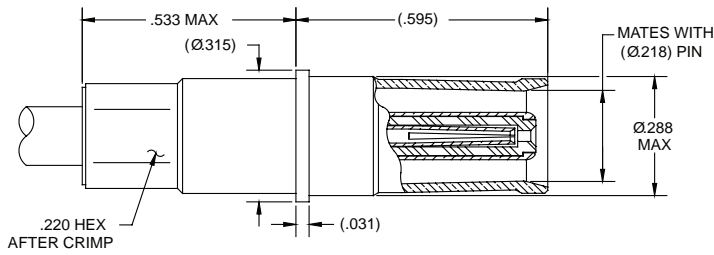

Part Number	Cable Type	Cable
019512-2123	Flexible Twinax	M17/176-00002
019512-2124	Flexible Twinax	540-1161-000
019512-2125	Flexible Twinax	540-1086-000

Size 8 MIL-DTL-83527 Twinax/Triax Pin Contact

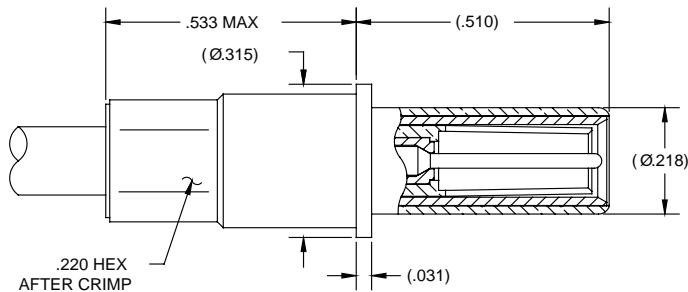

Part Number	Cable Type	Cable
019612-2125	Flexible Twinax	M17/176-00002
019612-2126	Flexible Twinax	540-1161-000
019612-2127	Flexible Twinax	540-1086-000

Size 9 ARINC 404 Twinax/Triax Socket Contact

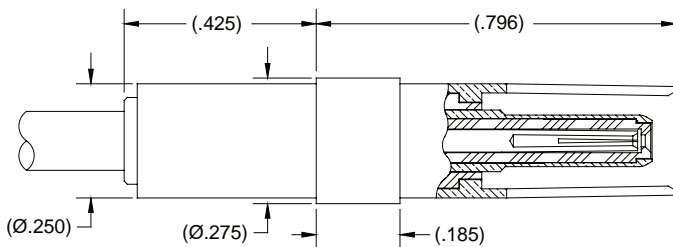

Part Number	Cable Type	Cable
019112-2001	Flexible Twinax	M17/176-00002
019112-2002	Flexible Twinax	540-1086-000
019112-2003	Flexible Triax	RG-403
019112-2004	Flexible Triax	540-1050-000
019112-2031	Flexible Triax	540-1081-000

Size 9 ARINC 404 Twinax/Triax Pin Contact

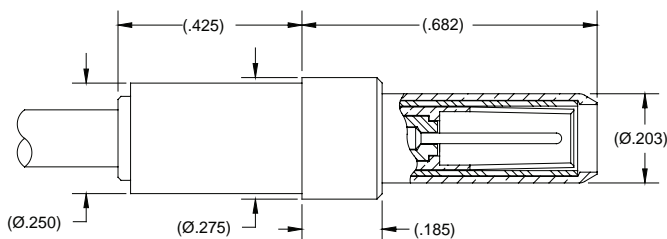

Part Number	Cable Type	Cable
019212-2001	Flexible Twinax	M17/176-00002
019212-2002	Flexible Twinax	540-1086-000
019212-2003	Flexible Triax	RG-403
019212-2004	Flexible Triax	540-1050-000
019212-2031	Flexible Triax	540-1081-000



MIL-DTL-38999 PC Tail Triax Contacts

Size 8, 10 and 12 Twinax/Triax PC Tail Contacts

Size 8 MIL-C-39029/90 PC Tail Twinax/Triax Pin Contact

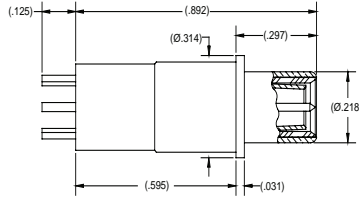
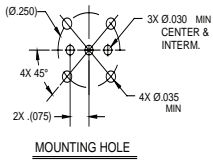

P/N 019617-2100

Size 8 MIL-C-39029/91 PC Tail Twinax/Triax Socket Contact

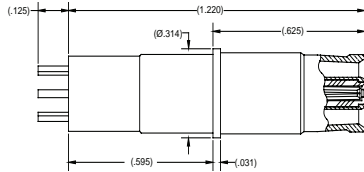
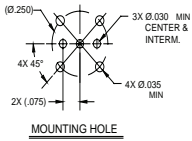

P/N 019517-2100

Size 10 MIL-DTL-38999 PC Tail Twinax/Triax Pin Contact

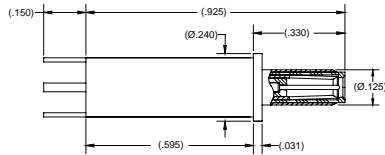
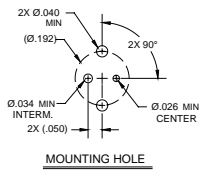

P/N 018817-2100

Size 10 MIL-DTL-38999 PC Tail Twinax/Triax Socket Contact

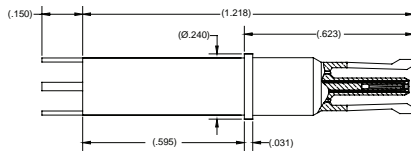
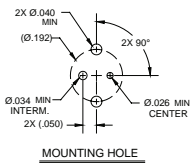

P/N 018917-2100

Size 12 MIL-DTL-38999 PC Tail Twinax/Triax Pin Contact

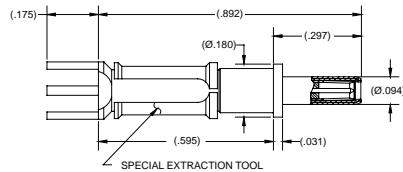
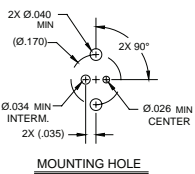

P/N 018617-2100

Size 12 MIL-DTL-38999 PC Tail Twinax/Triax Socket Contact

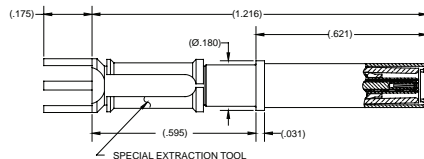
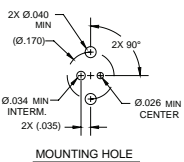

P/N 018717-2100

Note:

Sabritec Twinax/Triax PC Tail Contacts are only available installed into an applicable Sabritec connector. These items are not sold separately.